

SPECIFICATION

1. SCOPE

This specification is applied to the piezo-element.

2. SPECIFICATION

(at 25°C)

2.1 Resonant Frequency	:	2.9±0.5 KHz
2.2 Resonant Resistance	:	350 Ω max
2.3 Capacitance	:	32000 pF±30% at 100Hz
2.4 Input Voltage	:	30 Vp-p max
2.5 Operating Temperature	:	-20~+50°C
2.6 Storage Temperature	:	-20~+60°C
3. DIMENSION	:	as per figure

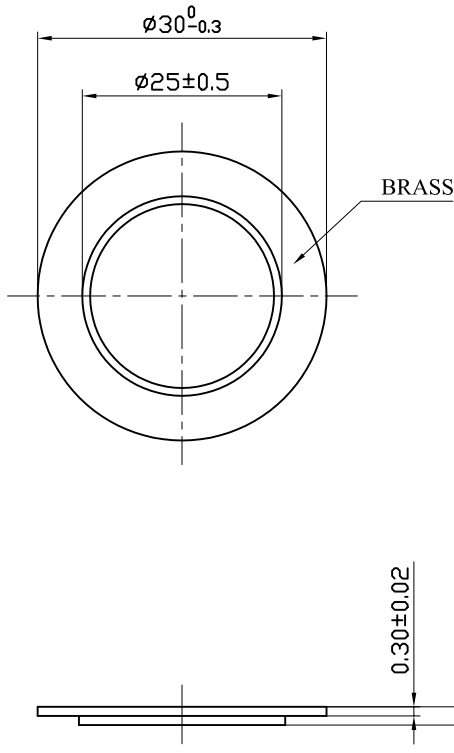

TOLERANCES UNLESS NOTED OTHERWISE

.X ±
.XX ±
.XXX ±

90° FORMED +2°
ANGLES -1°

FIRST ANGLE PROJECTION

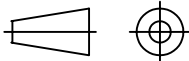

DRAWN	
DESIGN	
CHECKED	
APPROVED	
DATE	03.08.07
CONTRACT NO.	
AGENCY APPROVAL	

KEPO MODEL NO.

MFT-35T-2.9A1

DWG NO.

KP3.842.759

KEPO CO., LTD.

CUSTOMER

CUSTOMER NO.

VER	1.1	SCALE	
UNIT	mm	SHEET	

TEL:(+86)574-88370330
FAX:(+86)574-88370329